

This Quick Start Guide is provided so that you can properly set up your new TV.

1 PACKAGE CONTENT

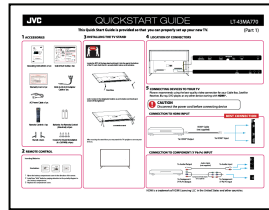

TV x 1pc



Quick Start Guide x 1pc



Warranty Card x 1pc



Remote Control x 1pc

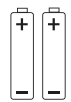

Batteries for Remote Control (Size AAA) x 2pcs



4x screws for TV Stand

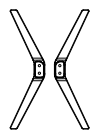

Stands x 2pcs

2 INSTALLING THE TV STAND

It is recommended two people handle TV stand installation. To prevent scratch or damage to the TV screen, place the TV on a soft, flat surface.

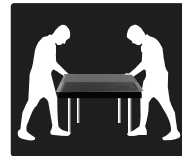

Attach the stands to the bottom of the TV by inserting the stand into slots on the TV. Secure the stands to the TV with the supplied screws.

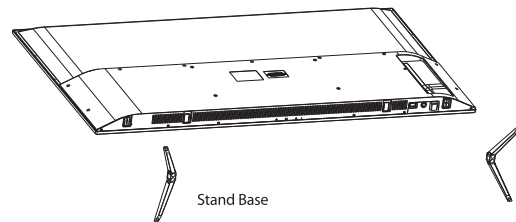

After securing the stand, place the TV on a stable surface. Note: TV can also be wall mounted. Wall mount sold separately.

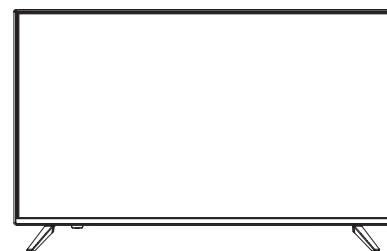

3 LOCATION OF CONNECTORS

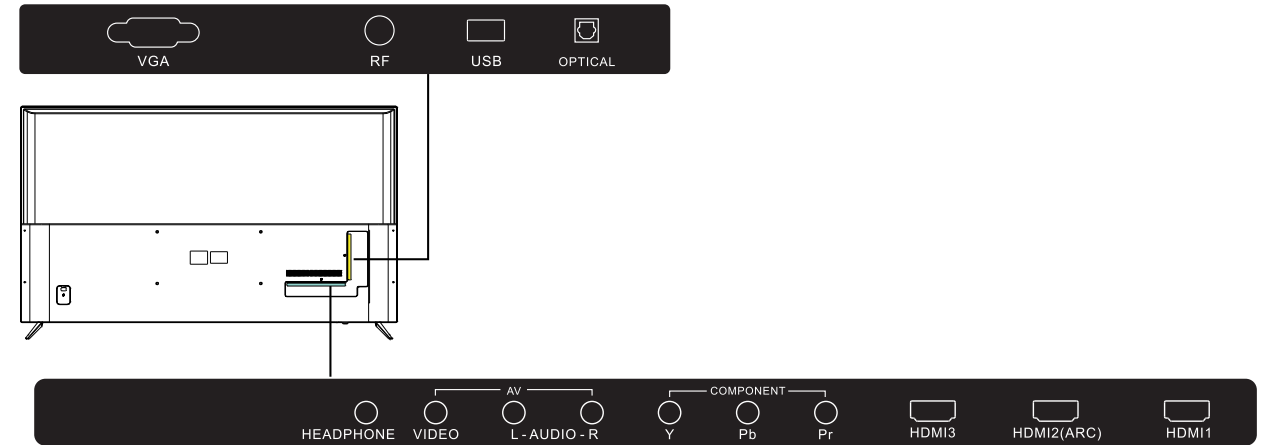

CONNECTING DEVICES TO YOUR TV

JVC recommends using the best-quality video connection for your Cable Box, Satellite Receiver, Blu-ray, DVD player, Game box or any other device starting with **HDMI®**.



CAUTION

Disconnect the power cord before connecting device

CONNECTION TO HDMI INPUT

BEST CONNECTION

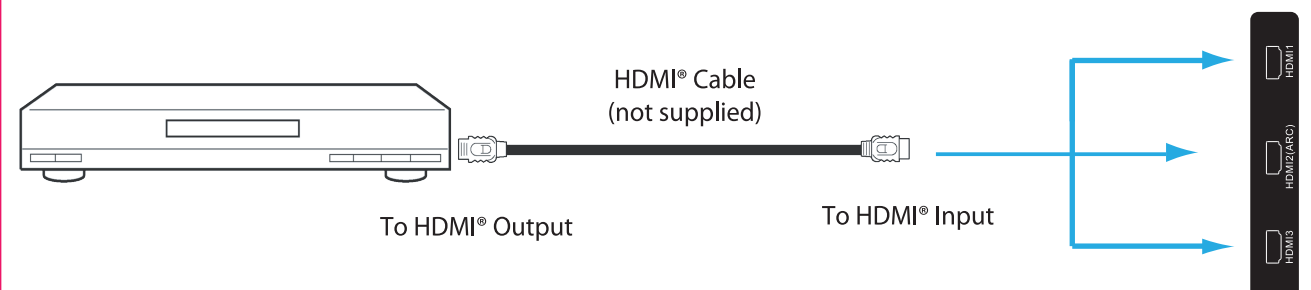

CONNECTION TO COMPONENT (Y Pb Pr) INPUT

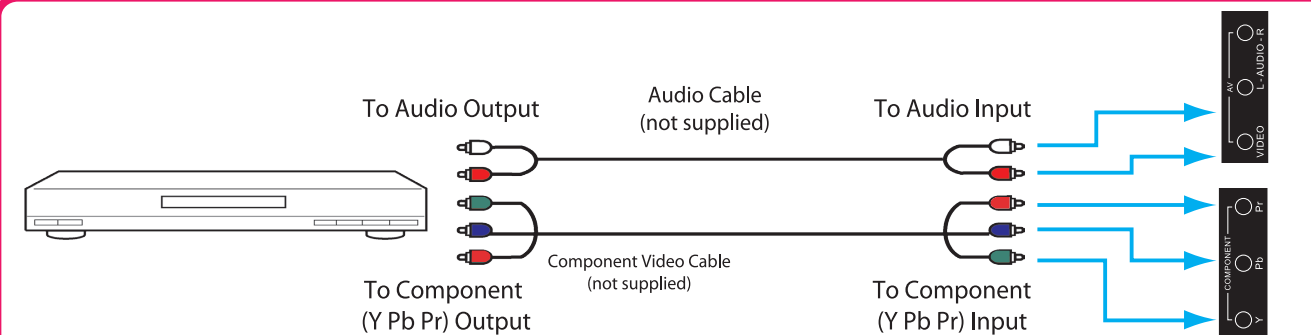

4 CONNECTING DEVICES TO YOUR TV (Cont.) CONNECTION TO AUDIO/VIDEO INPUT

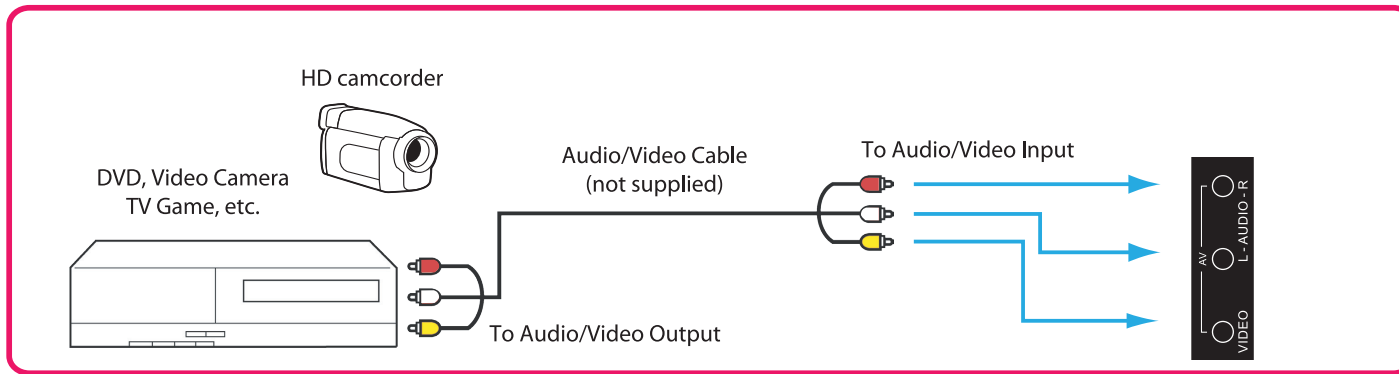

ANTENNA/CABLE CONNECTIONS

If you are connecting to a cable or Satellite Receiver then the setup process ends here. You can simply turn on the TV, press the "INPUT/SOURCE" button on the remote control and scroll to your appropriate input that matches your connection. I.E: If you connected your cable to **HDMI 1**, then you switch the source to **HDMI 1** in the Source Menu.

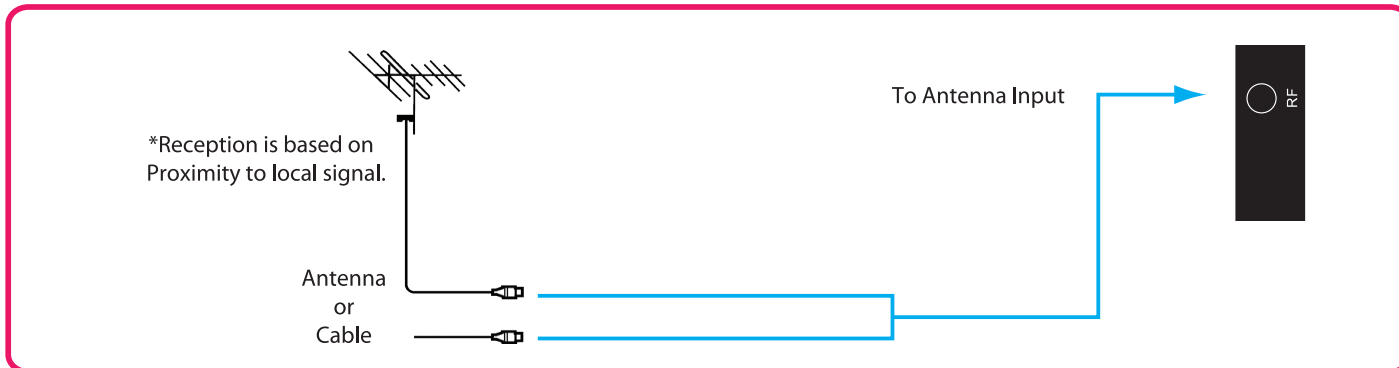

CONNECTION TO PC (VGA) INPUT

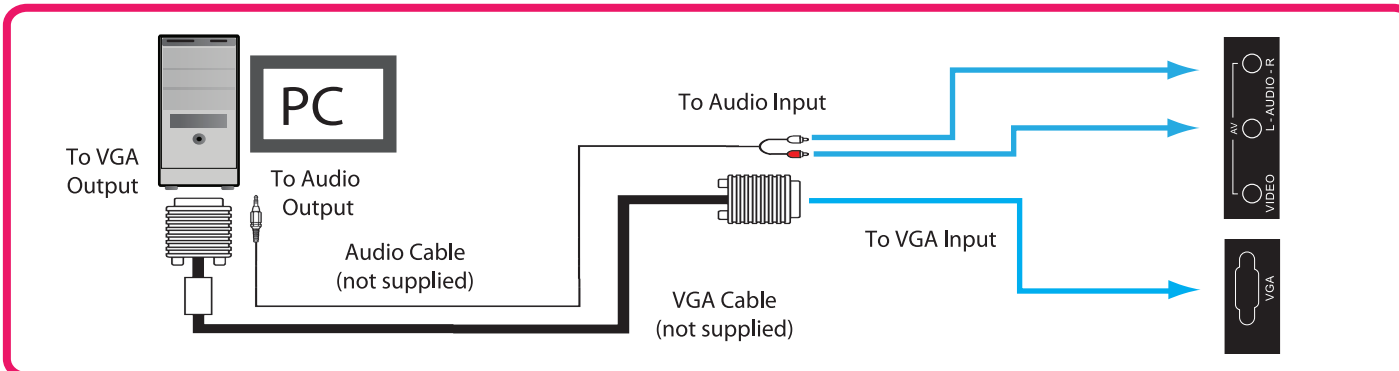

5 POWER CORD CONNECTION & POWER ON

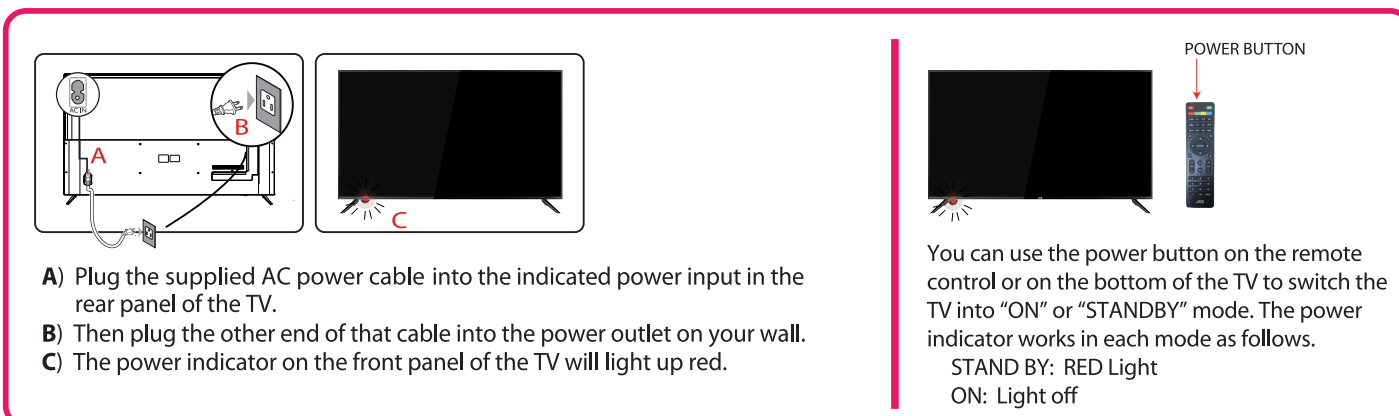

6 INITIAL SET UP

The first time you power on the TV, you will be asked to run the Channel Scan. Please follow the instruction on the screen to select the channels that are available to you via your cable or digital antenna.

If you want to receive Cable TV signal through the antenna, the Air/Cable menu option must be switched to Cable (Cable TV) mode. Follow the steps in Initial Set Up 1. If you want to receive the over-the-air broadcast signals by connecting to the digital antenna to the antenna input terminal, skip the Initial Set Up 1 and go directly to Initial Set Up 2.

Press Menu Button first if you skipped Initial Setup1.

Initial Setup 1

1. Select Menu Language.



2. Select "Time Zone" and "DST".



3. Select "Air/Cable" by using ▲▼ keys, and change from "Cable" to "Air" by using ◀▶ keys and press "Enter".



4. Press Enter key to start Auto Scan, and the following screen shows up to indicate the progress.

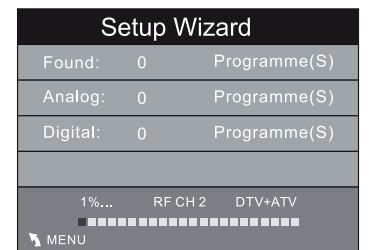

After this process is completed, you can view your local or cable channels by pressing the corresponding channel numbers or by pressing Channel Up or Down buttons.